

Foot
Ordering No. 4430 0189 80

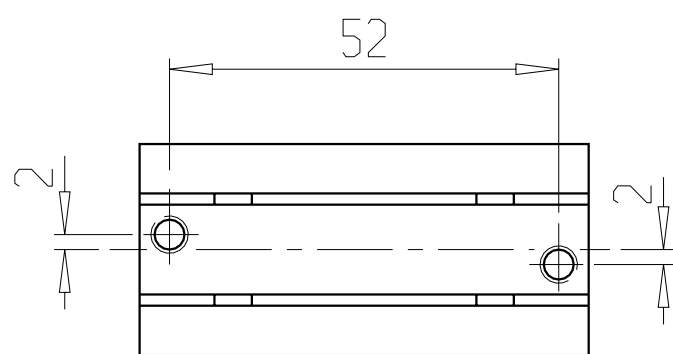

Flange
Ordering No. 4430 0165 85

